



Simplis[®]

Simplifying Interior
Solutions

CHRISTO RISER DOORS

Revelation Through Concealment



FITTING INSTRUCTIONS

www.simplis.co.uk



REVELATION THROUGH CONCEALMENT

Thank you for choosing the Christo Riser Door System made with care in our Lincolnshire factory. Please read this installation guide to help make the fitting process easier and see the video fitting guides on the website.

Important Fire Rating Notice

The Christo Riser Door is a passive fire rated protection product that has successfully passed fire tests for over 2 hours. However, the fire rating of any doorset is subject to a number of factors including the design of the partition, installation and fire stopping. Please ensure the partition meets the required fire performance criteria and the installation and fire stopping is carried out correctly. If there is any doubt please contact us.

Scan the QR code to watch the fitting installation video. Just point your camera phone at the image.

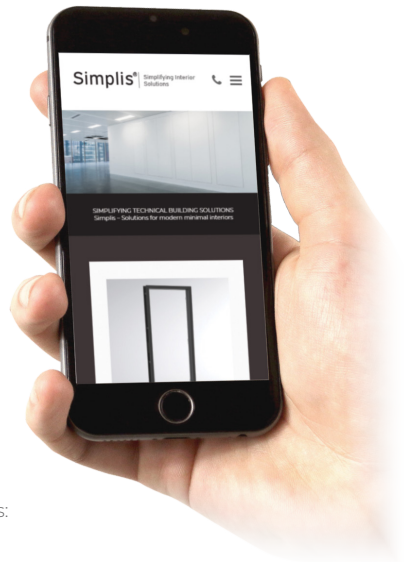

REQUIRED TOOLS

Before you proceed with installation, you will require these tools:



Spirit Level



Cordless Drill



Screwdriver



Stanley Knife



Assistant



Metal Packers



Tape Measure



Intumescent Sealant

BEFORE STARTING



Simplis[®]

Simplifying Interior
Solutions

Please see our recommendations below before installation.

Check the Door

Before opening the packaging please check for damage. The Christo Riser Door System is protected with oversized polystyrene corners and heat shrink wrapped in heavy duty polythene. Please recycle all the packaging. There will be printed labels with Number/Type/Position/Floor and Size at the door ends, edges and the back of the door. Please ensure the information corresponds with the installation position.

Check the Wall

The partition will need to be constructed to meet the required fire performance. Steel studs lining the aperture should be fitted with timber inserts where the wall system permits. Exposed timber lining studs will need to be protected with plasterboard. Steel lining studs can be left exposed. Internal frame fixing positions will be 54mm & 78mm back from the wall face. For the Beaded Frame type the doorset should also be face fixed through the beaded flange.

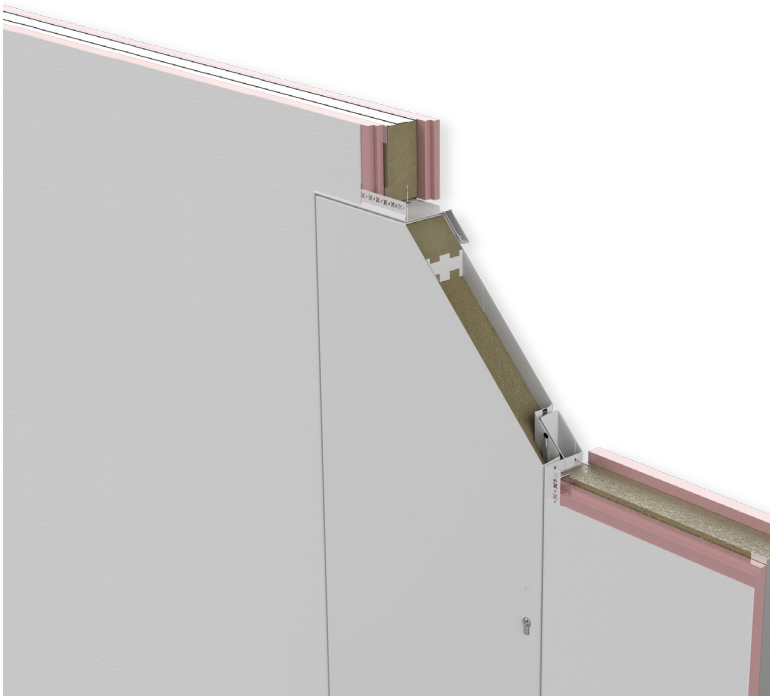

SINGLE DOOR INSTALLATION

The single door is supplied assembled in the door frame.

1. CONSTRUCT THE OPENING

Carefully prepare the opening in the wall 10mm larger than the doorset ordered to allow for fitting adjustment. The opening must be square, plumb and level.

2. PACKER PLATE & PIVOT CUTOUTS

Cut away a square of plasterboard at the head of the door 15mm high x 15mm wide x 15mm deep and 15mm from the hinge side to allow top pivot clearance. Place a 5mm packer under the bottom hinge stud position below the top pivot position.

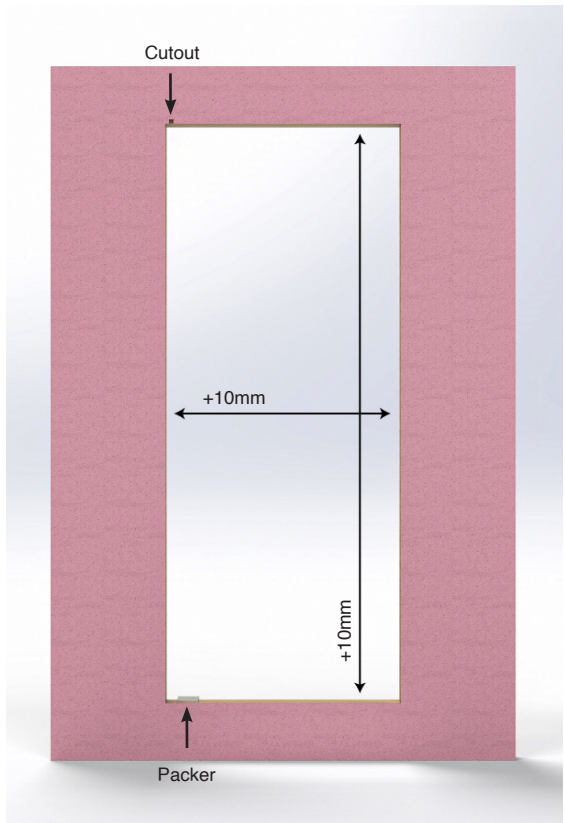



Simplis[®]

Simplifying Interior
Solutions

3. TAKE THE DOOR OUT OF THE FRAME

Remove the door from the frame.



4. OFFER THE FRAME TO THE APERTURE

Taking care not to dislodge the bottom packer offer the frame to the opening. Plumb the hinge side and fix into place with two screws. Do not twist the frame. Use minimum 45mm x 5mm Drywall fixings or longer to suit your wall construction.



5. FIX THE CLOSING SIDE

Place two screws in the closing side.



6. OFFER THE DOOR INTO THE FRAME

Hanging the door is a two man operation. A Riser Door can weigh 40kg+. Place the door leaf onto the bottom pivot point with the nylon spacer washer and lift the door into place. Hold the top spring pivot barrel down which will pop up when it locates into its hole. Visually check the pivot barrel has located correctly by checking the access hole in the side of the door.



7. HOW TO REMOVE THE DOOR

To remove the door unlatch the top pivot using the access point in the side of the door and lift the door off the bottom pivot.



8.

CHECK THE GAPS

The top and bottom door/frame gaps should be the same as the hinge and closing edge. Move the closing edge vertically up or down to adjust the top and bottom gaps. Plastic caps installed into the bottom and head of the door will maintain a consistent gap after adjustment. If necessary adjust the packer under the bottom pivot position.

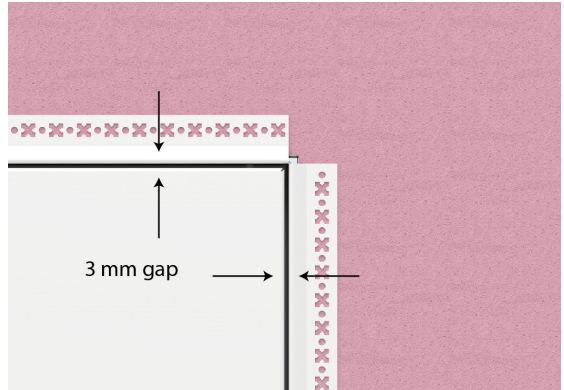

9.

CHECK THE OPENING & CLOSING

The door should now open and close without rubbing on the frame. Adjust where required.

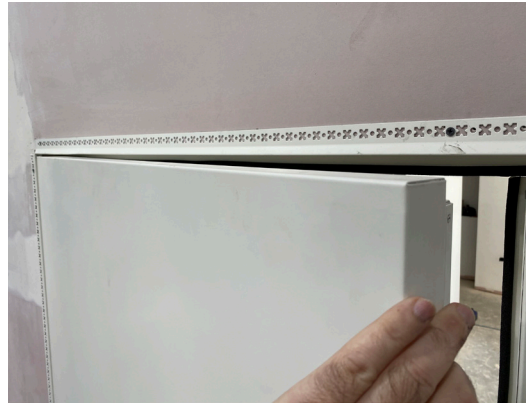

10.

COMPLETE THE FACE FIXINGS

Fix through the beaded flange at 200mm centres and double fix at each corner. Use 45mm x 5mm Drywall screws. Check the opening action again.

Picture Frame

Skip this step for Picture Frame installation.



11. FIX INSIDE THE FRAME

Internally fix the frame using the pre-punched holes in the frame edges. Use 45mm x 5mm (min) drywall fixings at 260mm centres. Use steel or non-combustible packers between the frame and opening to prevent the frame twisting. Any steel packer can be used or they are available from The Access Panel Co.



12. RECHECK THE OPENING & CLOSING

The door should now open and close without rubbing on the frame. Adjust where required.



13. CHECK LOCK OPERATION

Do not lock the door before checking the operation. With the door in the open position operate the lock several times. The lock should operate smoothly without sticking. Use the adjusters to move the locking rods forwards or backwards to align the door into the frame. If the wall is not perfectly plumb the rods will slightly correct for any inconsistency.



14. ACOUSTIC & FIRESTOPPING

For small gaps less than 5mm run a bead of Nullifire FS702 Intumescent Acrylic Sealant (or alternative Certifire approved) to the frame and wall junction as shown. For larger gaps fill the gap with Rockwool and then apply the bead as above. See the separate Firestopping Data Sheet.



15. TAPE & JOINT/ PLASTER

Use scrim cloth self-adhesive tape. Plaster or tape and joint as required.



16. CERTIFIRE

Christo Riser Doors are third party certified by the Certifire scheme in certain configurations and sizes. If the door has been specified and is being installed under the Certifire or other third party certification scheme please follow the scheme registration procedures.



DOUBLE DOOR INSTALLATION

Double doors arrive with each door wrapped with half the frame.

1. CONSTRUCT THE OPENING

Carefully prepare the opening in the wall 10mm larger than the doorset ordered to allow for fitting adjustment. The opening must be square, plumb and level for a good result.

2. PACKER PLATE & PIVOT CUTOUTS

Cut away a square of plasterboard at the head of the doors 15mm high x 15mm wide x 15mm deep and 15mm from the hinge side to allow for the full travel of the top pivot position. Place a 5mm packer under the bottom hinge stud positions.

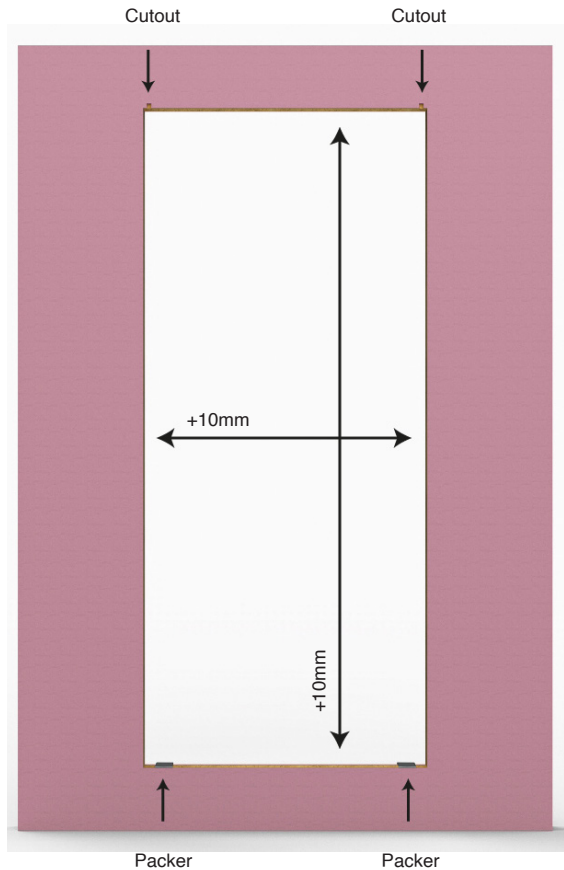



Simplis[®]

Simplifying Interior
Solutions

3. UNPACK THE DOORS

Each pack should include a door, half a frame and a frame joining plate. Joining plate screws will be fitted in the joining plate or bagged separately. A key will be taped to the back of the door.



4. TAKE THE DOORS OUT OF THE FRAME

Remove the doors from the frames.



5. ASSEMBLE THE FRAME

On a flat surface use the joining plates to connect the two frame halves.

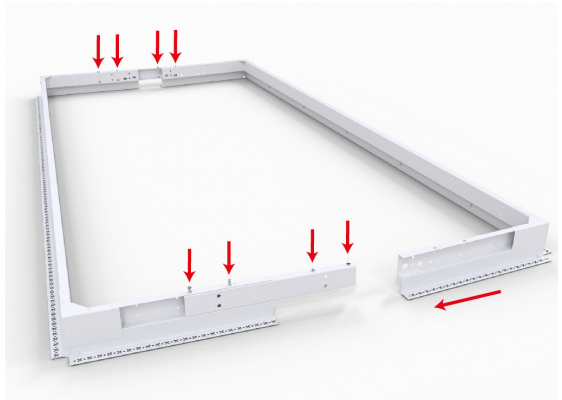

6. OFFER THE FRAME TO THE APERTURE

Taking care not to dislodge the bottom packers offer the frame to the opening.



7. FIX THE CLOSING SIDES

Using a screw on each side, plumb and level the frame. The joining plates can be relaxed to allow some adjustment. Use minimum 45mm x 5mm Drywall fixings or longer to suit your wall construction.



8. FIX THE CORNERS

With the frame plumb, level and square, fix at each corner position. Be careful not to distort the frame.



9. OFFER THE DOORS INTO THE FRAME

Hanging the doors is a two man operation. A Riser Door can weigh 40kg+. Place the door leaf onto the bottom pivot point with the nylon spacer washer and lift the door into place. Hold the top spring pivot barrel down which will pop up when it locates into its hole. Visually check the pivot barrel has located correctly by checking the access hole in the side of the door.



10. HOW TO INSTALL OR REMOVE THE DOORS

To remove the door unlatch the top pivot using the access point in the side of the door and lift the door off the bottom pivot.



11. CHECK THE GAPS

The top and bottom door/frame gaps should be the same as the hinge edges. Move the hinge edges vertically up or down to adjust the top and bottom gaps. Plastic caps installed into the bottom and head of the door will maintain a consistent gap after adjustment. If necessary remove the packer under the bottom pivot position.

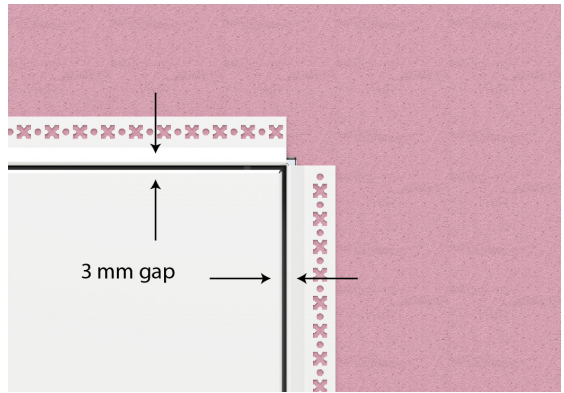

12. CHECK DOOR ALIGNMENT

Each door should be level with its pair. Joining plates can be slightly separated to open the gap between the doors. The picture shows the result of the frame fitted out of square. Correct the door adjustment by adjusting the frame.

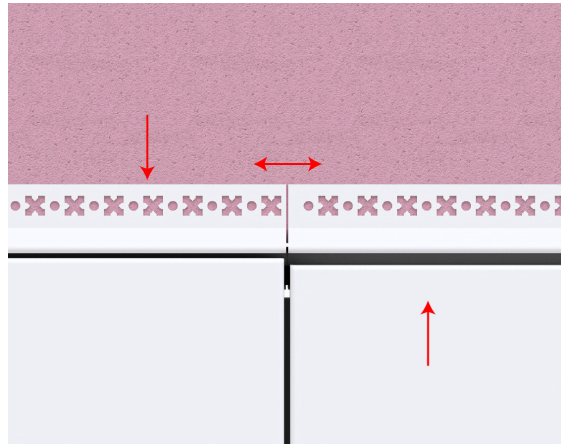

13. CHECK THE OPENING & CLOSING

The doors should now open and close without rubbing on the frame. Adjust where required.



14. COMPLETE THE FACE FIXINGS

Fix through the beaded flange at 200mm centres and double fix at each corner. Use 45mm x 5mm Drywall screws. Check the opening action again.

Picture Frame

Skip this step for Picture Frame installation.



15. FINISH FIXING THE INNER FRAME POSITIONS

Internally fix the frame using the pre-punched holes in the frame edges. Use 45mm x 5mm (min) drywall fixings at 260mm centres. Use steel or non-combustible packers between the frame and opening to prevent the frame twisting. Any steel packer can be used or they are available from The Access Panel Co.



16. CHECK LOCK OPERATION

Do not lock the doors before checking the operation. With the passive leaf open, close and test lock the active leaf on its own before locking both together. Use the adjusters to move the locking rods forwards or backwards to align the doors into the frame. If the wall is not perfectly plumb the rods will slightly correct for any inconsistency.



17. ACOUSTIC & FIRESTOPPING

For small gaps less than 5mm run a bead of Nullfire FS702 Intumescent Acrylic Sealant (or alternative Certifire approved) to the frame and wall junction as shown. For larger gaps fill the gap with Rockwool and then apply the bead as above. See the separate Firestopping Data Sheet.



18. TAPE & JOINT/ PLASTER

Use scrim cloth self-adhesive tape. Plaster or tape and joint as required.



19. CERTIFIRE

Christo Riser Doors are third party certified by the Certifire scheme in certain configurations and sizes. If the door has been specified and is being installed under the Certifire or other third party certification scheme please follow the scheme registration procedures.



20. LOCKING THE PASSIVE DOOR

Access the three point lock via the lock strike holes in the door edge.



MULTIPLE DOOR INSTALLATIONS

Multiple Doors arrive with each door wrapped with its frame parts and joining plates. Follow the instructions as the Double Door Installation. The Multiple Doors are more complex and more time should be allowed to achieve a good installation.

For technical advice please call.



NEED ADVICE

If you require any assistance in specifying your Christo Riser Door or have any other queries, please contact our friendly technical sales team. If you require a product that you cannot find on our website, please call to see if we can help you with your project.

Tel: 0345 556 4110

Email: sales@simplics.co.uk

If you would like to see more of our products visit our website at www.simplics.co.uk.





Simplis[®]

Simplifying Interior
Solutions

© 2021 by Simplis. All rights reserved

Where colour and finish samples are shown within this document limitations in the reprographics process mean absolute colour accuracy cannot be guaranteed. Where colour matching is critical, a sample of the material can be provided on request. Simplis reserves the right to alter specification and designs without prior notice.

www.simplis.co.uk